

# myRobot<sup>®</sup> C E N T E R

The expert for robots in your home

With one click to the online shop



[myRobotcenter.eu](https://myRobotcenter.eu)



[myRobotcenter.co.uk](https://myRobotcenter.co.uk)



myRobotcenter



# User guide





# Meet your Neato Intelligent Robot Vacuum

**Congratulations** for choosing the Neato robot vacuum.

Your Neato is designed from the ground up to deliver unparalleled performance and ease of use that will revolutionize your vacuuming experience.

We know you are excited to start using your Neato. Please take a few moments to read this manual and become familiar with your Neato to ensure you get the most benefit from using it.

## **IMPORTANT!** Read before continuing with setup

To ensure an optimum experience, observe the following guidelines:

- Keep your Neato indoors. It was not designed for outdoor use.
- Although Neato robots have a smart navigation system to avoid obstacles, your Neato may occasionally bump into furniture, objects, pets, and people.
- Remove small objects on the floor, such as stray socks, jewelry, and cords, as well as items that may be damaged by bumping.
- If the area to be cleaned has a cliff, drop, balcony, fireplace, stairs, or other areas where your Neato could fall or that represent danger, place a physical barrier or create a No-Go Zone. Neato Robotics is not responsible for any damage to furniture, rugs, or flooring.

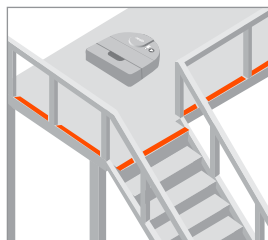

- Neato rotating brush works like the brush in a regular upright vacuum cleaner. Do not use the Neato on floors or rugs (especially those with fringes) where you would not use a regular upright vacuum.
- Shiny surfaces and black floors might cause navigation problems.
- Watch your Neato during the first few cleaning runs. Adjust the cleaning environment to optimize the robot's navigation. For example:
  - » Move or cover pet bowls and plant trays to keep your Neato away from liquids and wet areas.
  - » Clear the area of small items such as toys and clothing.
  - » Tie up wires, curtains, and other low-hanging items.

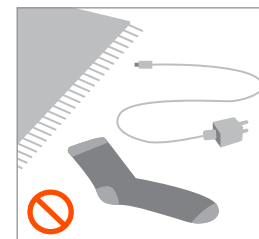

# Table of contents

Getting to know your Neato robot.....	3
Preparing to use your Neato robot.....	5
Connecting to the MyNeato app.....	6
Selecting a cleaning mode on the MyNeato app .....	7
Cleaning with the MyNeato app.....	8
Creating a Floor Plan Map and No-Go Zones.....	9
Schedule cleaning Routines and locating your Neato robot .....	10
Manually operating your Neato robot.....	11
Maintaining your Neato robot.....	12

## Related documents

In addition to this User Guide, the following documents are supplied with your Neato:

- **Quick start guide** — contains instructions to get your Neato up and running in the shortest possible time.
- **Important information & warranty** — contains safety, warranty, and other important information about your Neato.

### Getting Help

For helpful information, including how-to videos, frequently asked questions, and tips & tricks for optimal operation, go to <https://neatorobotics.com/support>. On your MyNeato app, you can also tap  to contact Neato Customer Care.

**If you need additional assistance, we are here to help. Contact us at: [neatorobotics.com/customer-care](https://neatorobotics.com/customer-care).**

# Getting to know your Neato robot

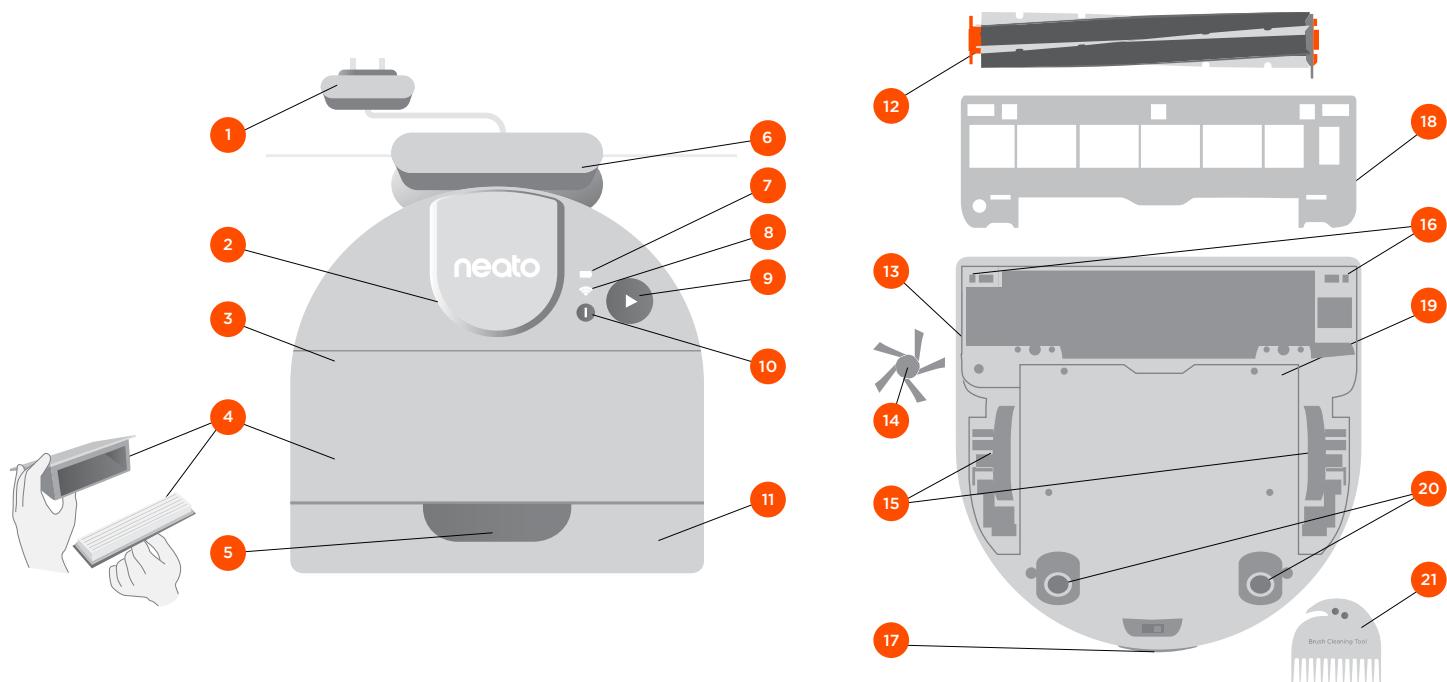

1 Power adapter  
(detachable supply unit)

2 Laser cover

3 Top

4 Dirt bin and filter

5 Handle

6 Charge base

7 Battery icon

8 Wi-Fi icon

9 Play button

10 Info button

11 Front bumper

12 Brush

13 Wall following sensor window

14 Side brush

15 Wheels

16 Drop sensor window

17 Charging contacts

18 Brush guard

19 Battery door

20 Bum rollers

21 Cleaning tool

## BATTERY LED

WHEN THE NEATO ROBOT IS...	BATTERY LED COLOR AND BEHAVIOR	MEANING (BATTERY CAPACITY LEVEL)
Off the charge base	Green	Battery level is full. Ready to clean.
	Yellow	Battery level is low. Move to charge base.
	Steady red	Battery level is critically low. Move to charge base.
	Fast blinking red	Battery has a fault and must be serviced.
On the charge base	Steady green	Battery power is at full charge. Ready to clean.
	Slow pulsing green	Battery power is at medium and battery is charging.
	Slow pulsing yellow	Battery power is low and battery is charging.
	Slow pulsing red	Battery power is critically low and battery is charging.
	Fast blinking red	Battery has a fault and must be serviced.

## WI-FI LED

WI-FI LED COLOR AND BEHAVIOR	MEANING
White	Neato is connected to Wi-Fi.
Pulsing white	Neato is trying to pair to the app via Bluetooth or connect to Wi-Fi.
Off	Neato is not connected to Wi-Fi.

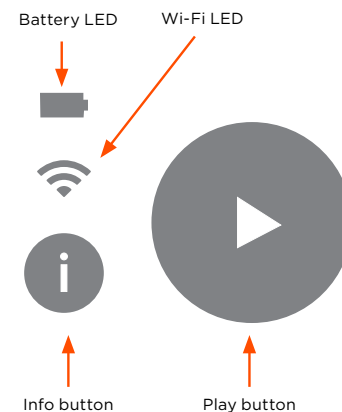

## PLAY BUTTON LED

PLAY LED COLOR AND BEHAVIOR	DESCRIPTION
White	Neato is awake and ready to clean or robot is cleaning.
Red sustained	An error has occurred. Press Info button to find out more about the error.
Pulsing white	Neato is paused.
Off	Neato is sleeping or powered off.

# Preparing to use your Neato robot

Before you start using your Neato, perform the setup instructions in this chapter.

## Positioning the charge base

Before positioning the charge base, select a clear area with good Wi-Fi coverage.



Begin by inserting the plug behind the charge base into an AC outlet. Shorten the cord as needed by wrapping it behind the charge base.

Make sure the charge base is against the wall and plugged in securely.

Place Neato against the charge base. When docked properly, the battery LED on the robot vacuum lights up.

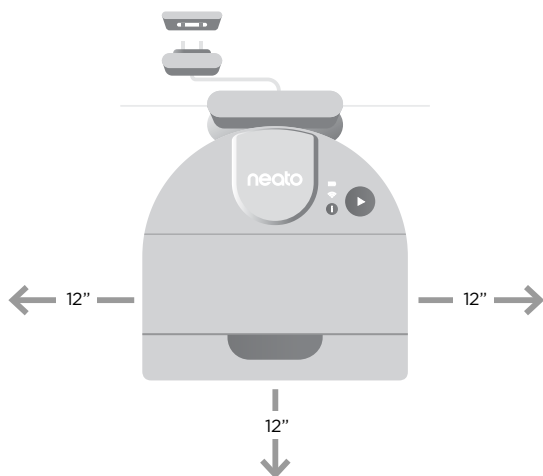

## Checking the battery

Your Neato battery comes partially charged. Before you use your Neato for the first time, position it at the charge base and allow the robot to charge until the battery LED becomes green (up to 3 hours).

**NOTE:** Always charge your Neato using the supplied Neato Original charge base and battery.

## Auto recharge and resume

If the area to be cleaned is very large, your Neato may need to recharge its battery before finishing the job. Once recharged, it will return to finish where it left off.

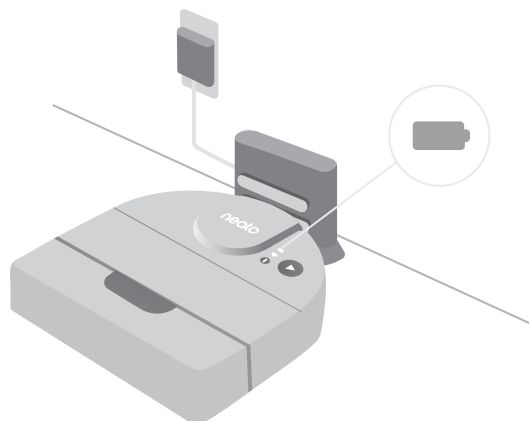



# Connecting to the MyNeato app

**⚠ IMPORTANT NOTE:** You must connect your Neato to the MyNeato app before using your robot vacuum.

1. Confirm that the charge base is positioned properly and within good Wi-Fi coverage.

2. Use this QR Code to download the MyNeato app from the Internet to your phone.

3. On your phone settings, turn on Bluetooth communication.

4. Complete the connection procedure by following the steps on the MyNeato app.

5. During the procedure, you will be asked whether you want to receive notifications from the MyNeato app. Allowing notifications permits your Neato to notify you about its status and alerts.



## The MyNeato app allows you to:

- Start and pause your Neato when you are not home
- Select cleaning modes: Eco, Turbo
- Get cleaning coverage map
- Create a Routine to schedule cleanings
- Receive cleaning status notifications instantly
- View battery status
- Receive notifications about Neato software updates
- Receive maintenance alerts and context-sensitive help to keep your Neato operation at its peak
- Get feature updates
- Chat with customer support for help

## Operating your Neato robot from multiple smartphones

You can use the MyNeato app on multiple smart devices in a household to operate the same Neato. Just download the MyNeato app to other smartphones and then sign into the same MyNeato account using the email and password originally used to set up your Neato.





# Selecting a cleaning mode on the MyNeato app

## Cleaning modes

Before you start, cleaning either with the MyNeato app or manually, you can select a cleaning mode to determine how your robot vacuum cleans.

By default, Neato uses Eco Mode. However, you can use the MyNeato app to change modes to suit your cleaning requirements. The following table describes the cleaning modes.

CLEANING MODES	DESCRIPTION
ECO 	Sets your Neato's brush and blower to medium power. This mode allows your Neato to clean the largest area on a single charge. Eco Mode is ideal for hardwood floors and is the quietest mode. This is the default mode.
TURBO 	Sets your Neato's brush and blower to high power. This mode provides stronger suction and a faster rotating brush. Turbo Mode is ideal for carpets, but consumes more battery power than Eco Mode.

**NOTE:** The cleaning mode you select applies to subsequent cleaning operations performed using the MyNeato app as well as a clean started by pressing the play button on your Neato.

## Extra Care navigation

In addition to the listed cleaning modes, your Neato supports an Extra Care navigation feature that is useful if you have especially delicate furniture. This feature is enabled from the same page on the MyNeato app where you select cleaning modes. When this feature is enabled, your Neato navigates more carefully and leaves a wider buffer around objects such as delicate pieces of furniture and chair legs. Extra Care navigation is available on D9 and D10 only.





# Cleaning with the MyNeato app

## Using the MyNeato app to clean

Your Neato cleans the entire floor plan on one level, moving automatically from room to room. From the app you can start cleaning, pause, resume, and cancel to return to charge base.

To clean a house:

1. Remove small objects and loose cords from the floor.
2. Make sure that your Neato is placed at the charge base.
3. Tap  to start cleaning.
4. Tap  to pause cleaning.
5. Tap  to continue cleaning.
6. Tap **Cancel and return to base** button to send your Neato back to the charge base.

During cleaning, your Neato comes off its charge base, explores its surroundings, and starts cleaning in sections approximately 15 x 15 feet (4.6 x 4.6 meters) in size, depending on layout and furniture. Your Neato continues to clean the entire room on one level, section by section, until the entire area is cleaned. It then moves from room to room to continue cleaning. If your Neato cleans a room partially, it will return to complete that room before finishing the job.

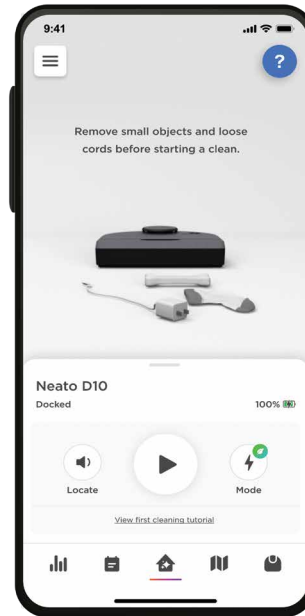

## Moving a Neato robot mid-cleaning

Do not pick up your Neato while it is moving. Otherwise, it can become disoriented, deviate from its normal smart behavior, and have difficulty finding its charge base.

To pause the cleaning, press  once while your Neato is cleaning. If you then lift your Neato, put it back down within 1 foot of where you picked it up.

# Creating a Floor Plan Map and No-Go Zones

## Creating a Floor Plan Map

Creating a floor plan map of your house allows you to set up No-Go Zones, so you can tell your Neato which areas of your house you want to avoid cleaning.

After your Neato performs its first cleaning using the MyNeato app, it creates a map of your house automatically. To view the map, tap  in the MyNeato app. For best results, remove small objects and loose cords from the floor and start cleaning the whole house on your first run.

**NOTE:** You must start cleaning from the charge base to create a Floor Plan Map.

From map view, you can select  to create No-Go Zones, name, and delete your maps.



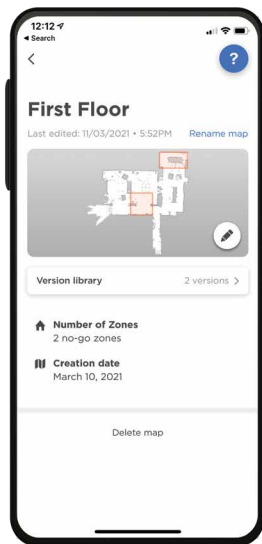

**NOTE:** If your Neato has not yet performed an initial cleaning, you will not see a map. In this case, tap  to start cleaning. A floor plan will be created after the first cleaning.



## Creating No-Go Zones

No-Go Zones allow you to tell your Neato to avoid areas that should not be cleaned, such as a child's play area or a dog bowl.

No-Go Zones are easy to set up using the MyNeato app:



1. Go to map view by tapping 
2. Create No-Go Zones in your map, by tapping 
3. Select 
4. Drag a No-Go Zone rectangle to the area of the map that you want to select. You can adjust No-Go Zone size by enlarging or reducing the No-Go Zone rectangle. Repeat step 3 to add more No-Go Zones to the map.
5. Tap  on the top left of your screen and your No-Go Zones will be saved automatically.

# Schedule cleaning Routines and locating your Neato robot

## Creating Routines to schedule cleanings

You can schedule your Neato to clean an entire house on certain days and times by creating a Routine.

To set up a Routine:

1. Select  in the MyNeato app.
2. Tap  to add a new Routine.
3. Select day(s) and time during the week to schedule your cleaning.
4. Select Cleaning Modes
5. Tap the  to save your Routine

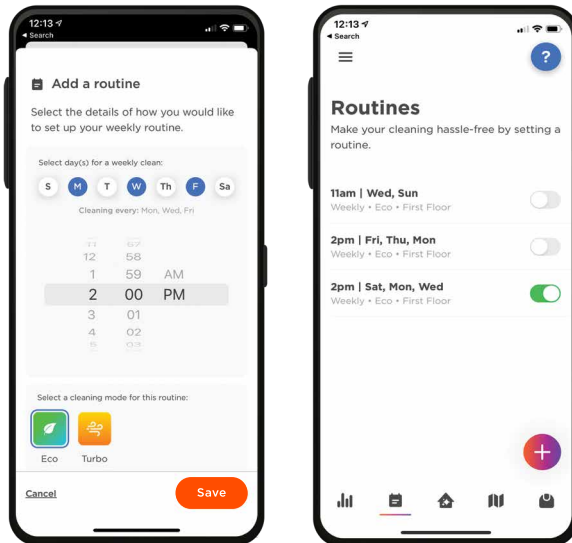

## Locating your Neato robot

There may be times when your Neato becomes stuck or stops at an unknown location in your house. When you tap  your Neato will make a sound which will guide you to find its physical location.

## Updating your Neato robot

Technology improves over time, and so will your Neato. For this reason, Neato will automatically update your robot and sends notifications to your MyNeato app, so you always have the latest features as soon as they are available.

## Troubleshooting your device

If an error occurs while operating your Neato, click the error link in the MyNeato app to see what the error means and what corrective action to take.

For more information, visit <https://neatorobotics.com/support>.

# Manually operating your Neato robot

**NOTE:** Before you start manual cleaning for the first time, you must connect your Neato to the MyNeato app. See *Connecting to the MyNeato App*.

## Cleaning an entire house

To clean your house, confirm that the Play LED is white. You can initiate cleaning by pressing  once. Your Neato robot will clean the entire floor on one level automatically moving room to room.

## Cleaning one room

If you just want to clean one room, you can manually place your Neato in the room, press  and close the door. Your Neato will clean the room and return to where you originally placed it. When your Neato has finished cleaning, please put it back on its charge base.

## PLAY BUTTON

PRESSING THE PLAY BUTTON...	PERFORMS THIS ACTION...
Press once when the Play LED is white.	Initiates a cleaning run.
Press once while the Neato is cleaning.	Pauses the cleaning run.
Press twice while the Neato is cleaning.	Cancels the cleaning run.
Long press for five seconds.	Shuts down the Neato robot.

## INFORMATION BUTTON

PRESSING THE INFO BUTTON...	PERFORMS THIS ACTION...
Short press when the Info button is white.	Hear information about the Neato robot's status.
Short press when the Info button is red.	Hear information about an error and how to resolve it.
Long press.	Hear information that the user is connected to the correct robot.
Long press while also pressing the Play button.	Performs a factory reset.

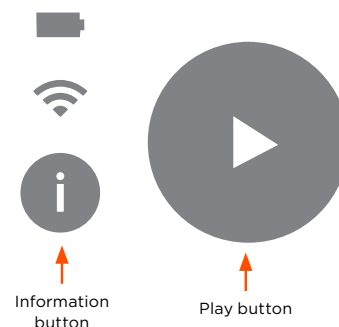

# Maintaining your Neato robot

For reliable operation, check and clean your Neato robot's brushes and empty its dirt bin after every use or as needed, depending on your environment. Failing to do this maintenance may impact your Neato's performance and may void your warranty coverage.

## Emptying dirt bin and cleaning filters

After each use, empty the dirt bin, clean the airways and opening, and clean the filter. To remove the filter, pinch the handle and pull out. Replace the filter every 1 to 2 months or more frequently as needed.

## Cleaning the brush

We recommend that you clean the brush monthly. Remove the side brush and set aside. Follow the steps below:

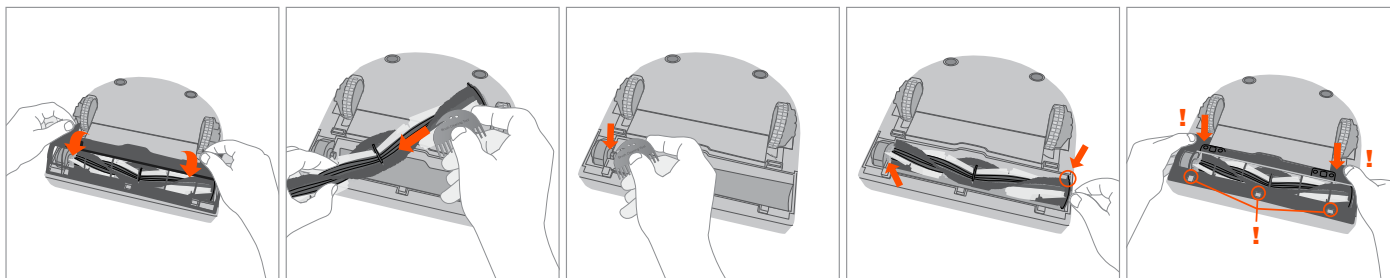
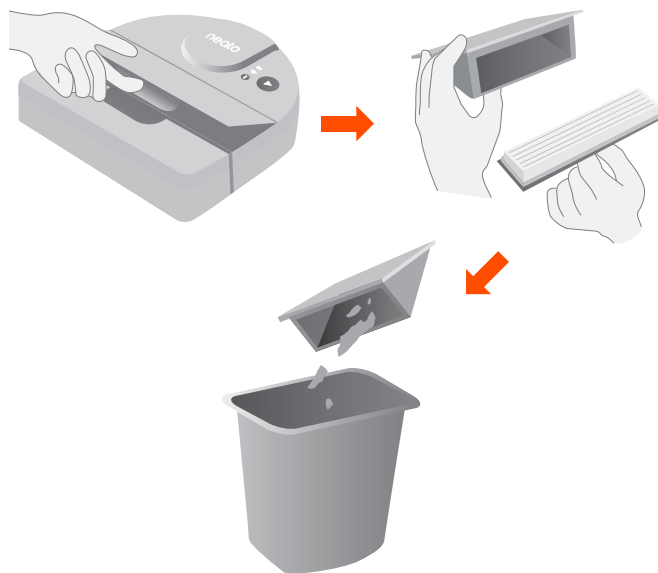

## Cleaning the top of the Neato robot

Clean the top of your Neato and the area around the laser top with a soft cotton cloth.

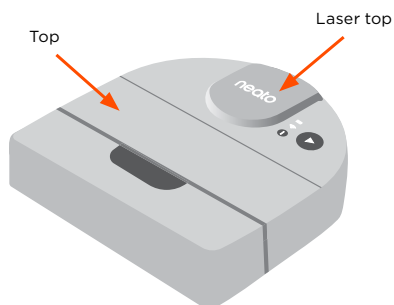

## Cleaning the sensors

Use a dry cotton swab to clean the three drop sensor windows on the bottom of your Neato.

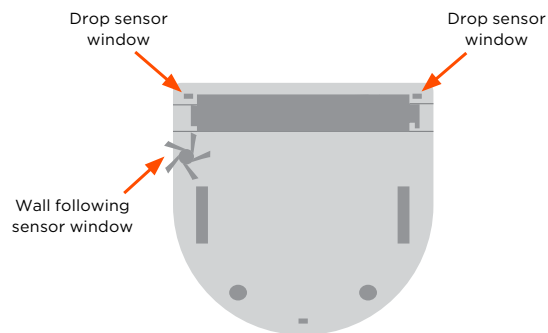

## Accessories

Always purchase Neato Original accessories and parts:

- Batteries
- Filters
- Brushes
- Cleaning tool
- Charge base

For information about accessories and replacement parts for your Neato, go to [neatorobotics.com](http://neatorobotics.com).

Using unauthorized or third-party (non-Neato Original) accessories can damage your Neato and will void your warranty.

Recommended replacement schedule depends on use.

**Filters** - every 1 to 2 months

**Brushes** - every 6 to 12 months

**Batteries** - every 12 to 18 months

**neato**<sup>®</sup>  
original



Neato Robotics®, Inc.  
50 Rio Robles  
San Jose, CA 95134, USA

**NeatoRobotics.com**



P/N 500-0102 Rev A